

UVA Sensor: SUVAT05

Features

SiC based material
 Broad band UVA+UVB+UVC photodiode
 Photovoltaic mode operation
 TO-46 metal housing
 Good visible blindness
 High responsivity and low dark current



Applications

UV LED monitoring
 UV radiation dose measurement
 UV Curing

Specifications

Parameter	Symbol	Value	Unit
Spectral characteristics (25 °C)			
Wavelength of peak responsivity	λ_{max}	275	nm
Peak responsivity (at 275 nm)	R_{max}	0.13	A/W
Spectral response range	-	200~380	nm
UV/visible rejection ratio ($R_{max}/R_{400\text{ nm}}$)	VB	$>10^4$	-
General characteristics (25 °C)			
Chip size	A	0.25	mm ²
Dark current (1 V reverse bias)	I_d	<10	pA
Capacitance (at 0 V and 1 MHz)	C	25	pF
Temperature coefficient	T_c	-0.1	%/°C
Maximum ratings			
Operation temperature range	T_{opt}	-40~125	°C
Storage temperature range	T_{stor}	-40~125	°C
Soldering temperature (3 s)	T_{sold}	260	°C
Reverse voltage	V_{Rmax}	20	V

Spectral response

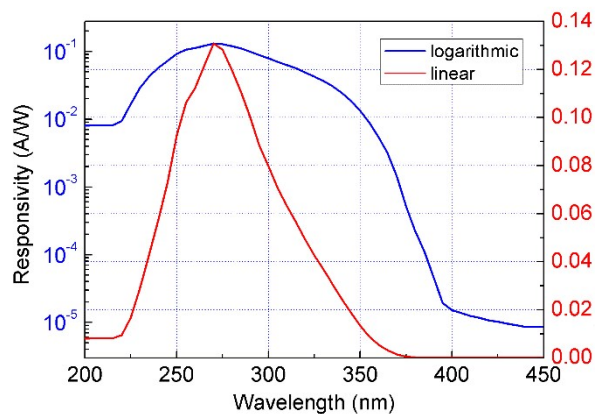

Package dimensions

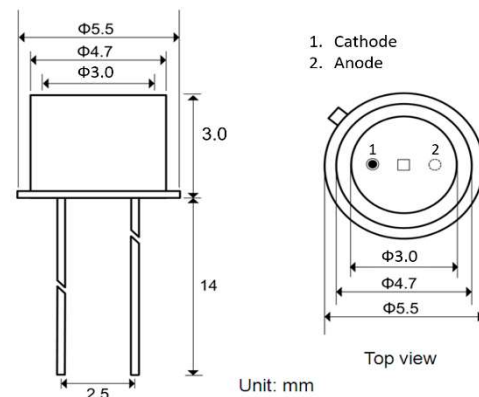

***Caution:** ESD can damage the device hence please avoid ESD.